

SEPTIČKA JAMA SJ-10-0,8

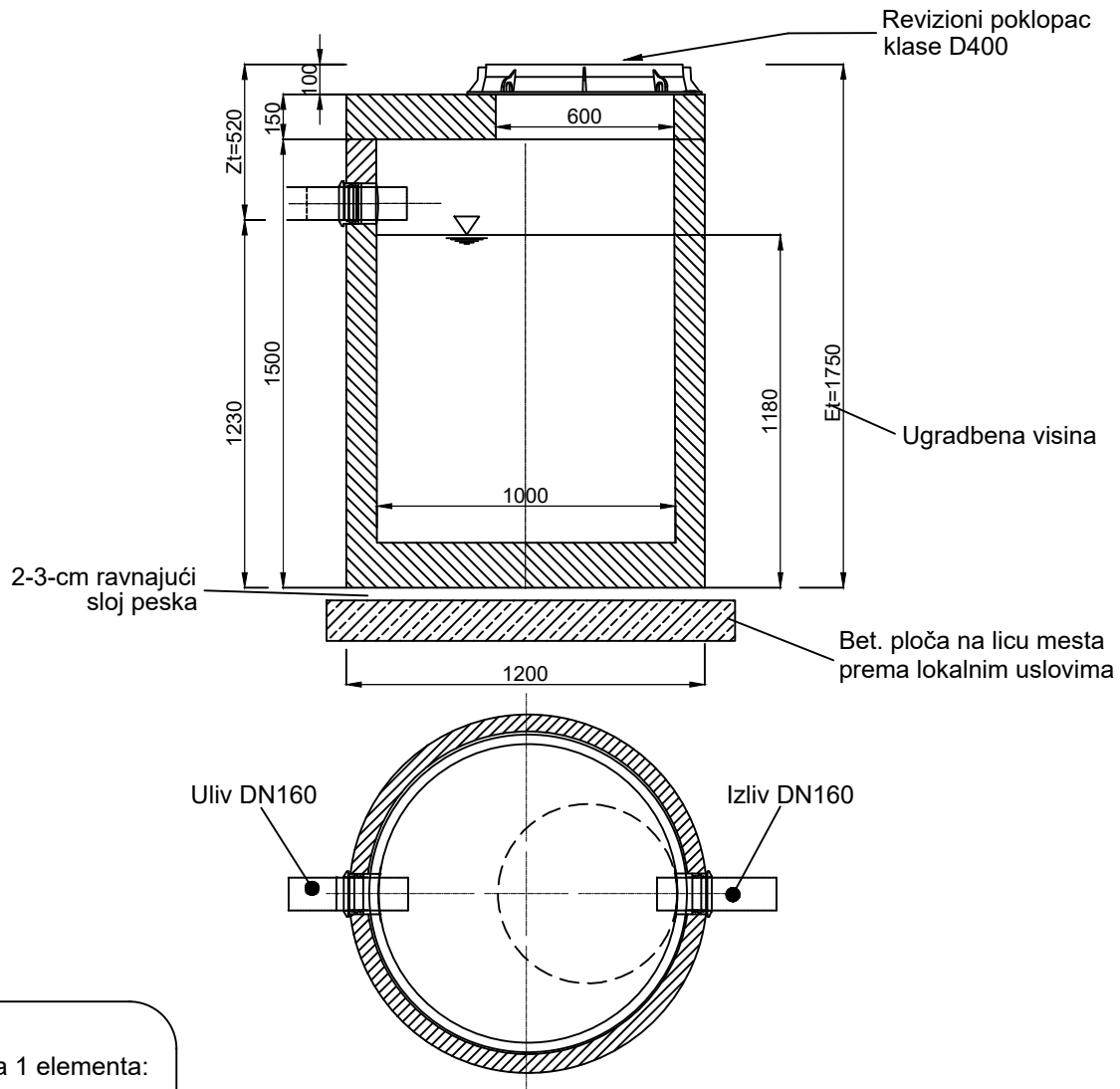

Max masa 1 elementa:
1.5 t

DN Uliv/Izliv 160mm

Vkor=0.8 m³

Ø 600 kl D400

purator
serbia
member of the wallner & neubert group

PURATOR Ekotehnika d.o.o.

ul. Kružni put 16a
Beograd, Leštane
office@purator.rs

tel.: +381 11 803 10 52
faks: +381 11 803 08 26
www.purator.rs

Naziv crteža:
Drawing name:

SEPTIČKA JAMA

Art.br: SJ-10-0,8

format:

A4

scale: