

## FCT tec NW 150

### 1. Kanal: tec NW150 V

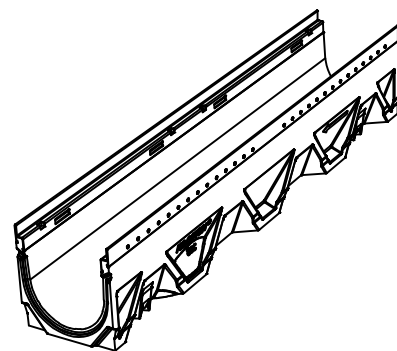
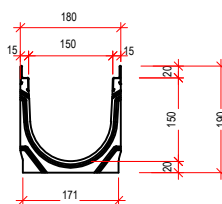
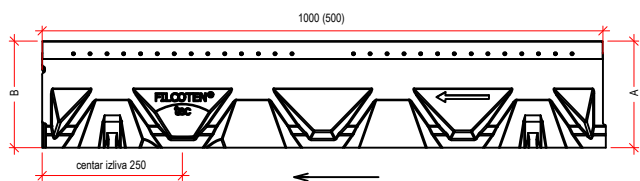

### 2. Mrežasta rešetka:

B125kN MW30/10: V 17015220 (17015221)

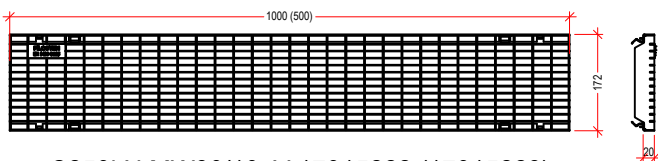

C250kN MW30/10: V 17015222 (17015223)

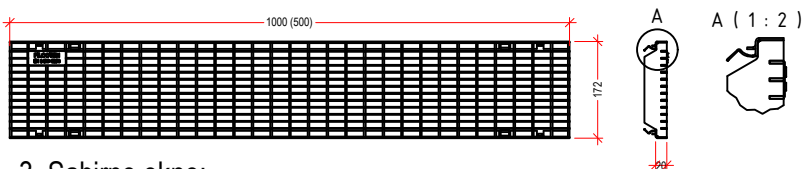

### 2. Liveno gvozdena rešetka/mrežasta:

C250kN MW29/13: GJS 17015101

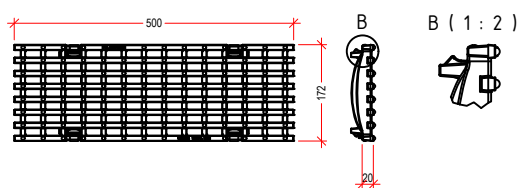

### 3. Sabirno okno:

(opcionarno: sifon DN 150: 30057, kofica za sabirno okno 22516  
V 10415291

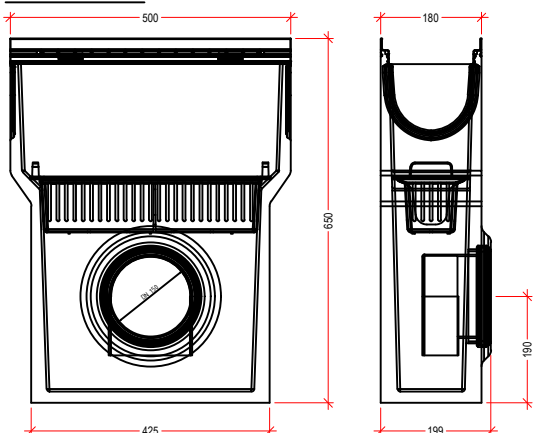

### 4. Čeoni poklopac/Čeoni poklopac sa izlivom:

V 19015230

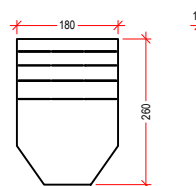

V 19015231

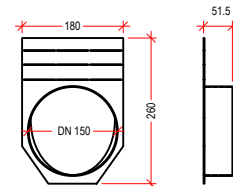

### 5. Anti-vandal sistem za zaključavanje rešetki NW 150 32087:

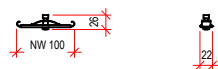

Kanal - dimenzije				
Tip	Visina A	Visina B	Dužina	BG code V
0	190	190	1000	10415200
0 (0,5m)	190	190	500	10415250

Legenda:	
V:	pocinkovani čelik (ivica)
E:	nerđajući čelik
GJS:	liveno gvozdje
H:	drvo

**purator**  
serbia  
member of the wallner & neubert group

PURATOR Ekotehnika d.o.o.  
ul. Kružni put 16a  
Beograd, Leštane  
office@purator.rs  
tel.: +381 11 803 10 52  
faks: +381 11 803 08 26  
www.purator.rs



www.bg-company.com

Naziv crteža:  
Drawing name:

**LINIJSKO ODVODNJAVANJE-FCT tec NW150**

Art.br:

10415200

format:

A4

scale: