

1. Kanal:
light NW100mini 55

FCT light NW 100 mini

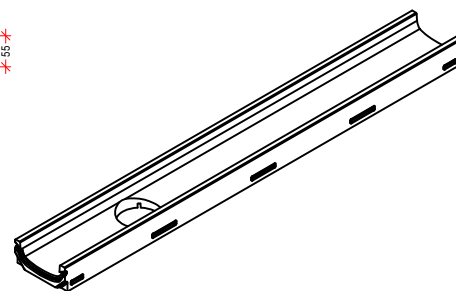

2. Mrežasta rešetka:
B125kN MW30/10: V 17010210 (17010211) E17010310 (17010311)

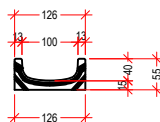
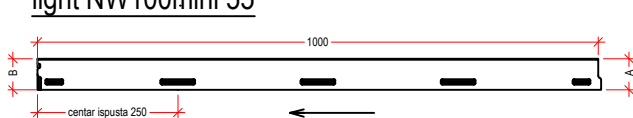
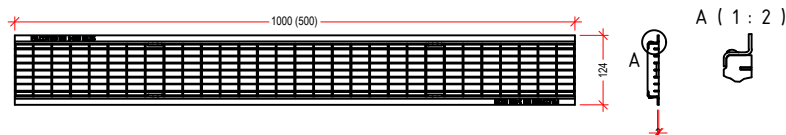

3. Sabirno okno:
V 10310093

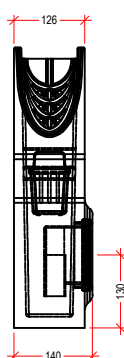
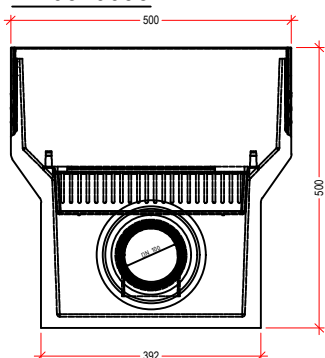

4. Čeoni poklopac mini:
V 19010200; E19010300

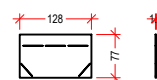

6. Element za zaključavanje za
liveno gvozdenu rešetku: 32068



6. Element za povezivanje za
mrežastu rešetku: 32080

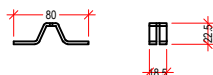

Element za povezivanje za liveno
gvozdenu rešetku 32067



Kanal/dimenzije				
Tip	Visina A	Visina B	Dužina	BG code
mini 55	55	55	1000	10110000

Legenda:	
V:	pocinkovani čelik (ivica)
E:	nerđajući čelik
GJS:	liveno gvožđe
H:	drvo



PURATOR Ekotehnika d.o.o.
ul. Kružni put 16a
Beograd, Leštane
office@purator.rs

tel.: +381 11 803 10 52
faks: +381 11 803 08 26
www.purator.rs



www.bg-company.com

Naziv crteža:
Drawing name:

LINIJSKO ODVODNJAVANJE-FCT light NW100 mini

Art.br: 10110000

format: A4
scale: