

1. Kanal:  
light NW100

FCT light NW 100

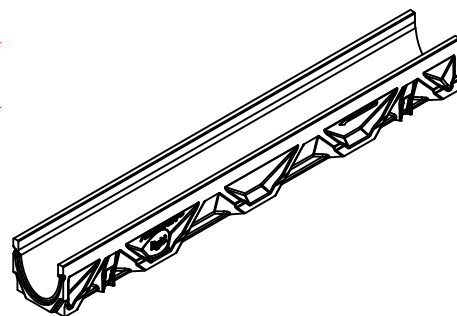

2. Mrežasta rešetka:  
B125kN MW30/10: V 17010210 (17010211) E17010310 (17010311)

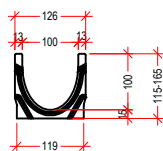
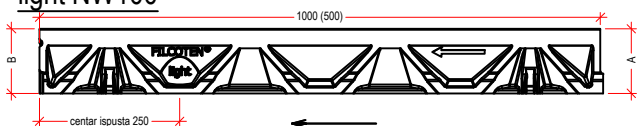
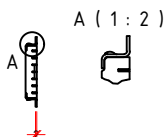
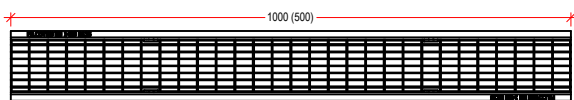

3. Sabirno okno:  
V 10310093

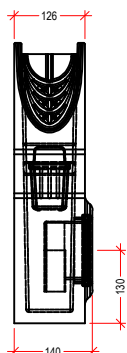
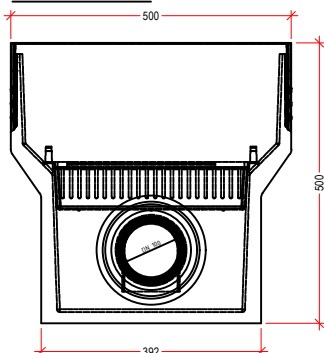

4. Čeoni poklopac/Čeoni poklopac sa izlivom:  
V 19010230; E19010330 V 19010232; E19010332

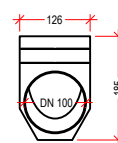
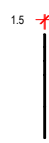
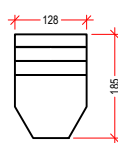

6. Element za zaključavanje za  
liveno gvozdenu rešetku: 32068



6. Element za povezivanje za  
mrežastu rešetku: 32080



Element za povezivanje za liveno  
gvozdenu rešetku 32067



Kanal/dimenzije				
Tip	Visina A	Visina B	Dužina	BG code
0	115	115	1000	10311000
0 (0,5m)	115	115	500	10311050
1	115	120	1000	10311001
2	120	125	1000	10311002
3	125	130	1000	10311003
4	130	135	1000	10311004
5	135	140	1000	10311005
5-0	140	140	1000	10311061
5-0(0,5m)	140	140	500	10311051
6	140	145	1000	10311006
7	145	150	1000	10311007
8	150	155	1000	10311008
9	155	160	1000	10311009
10	160	165	1000	10311010
10-0	165	165	1000	10311062

Legenda:	
V:	pocinkovani čelik (ivica)
E:	nerđajući čelik
GJS:	liveno gvožđe
H:	drvo



PURATOR Ekotehnika d.o.o.  
ul. Kružni put 16a tel.: +381 11 803 10 52  
Beograd, Leštane faks: +381 11 803 08 26  
office@purator.rs www.purator.rs



www.bg-company.com

Naziv crteža:  
Drawing name:

**LINIJSKO ODVODNJAVANJE-FCT light NW100**

Art.br:

10311000

format:

A4

scale: