

Tačkasta drenaža, sa mrežastom rešetkom, mogućnost prolaska automobila, sa sifonom i kolicom za mulj  
 Art br.: 14130001; 21,5kg

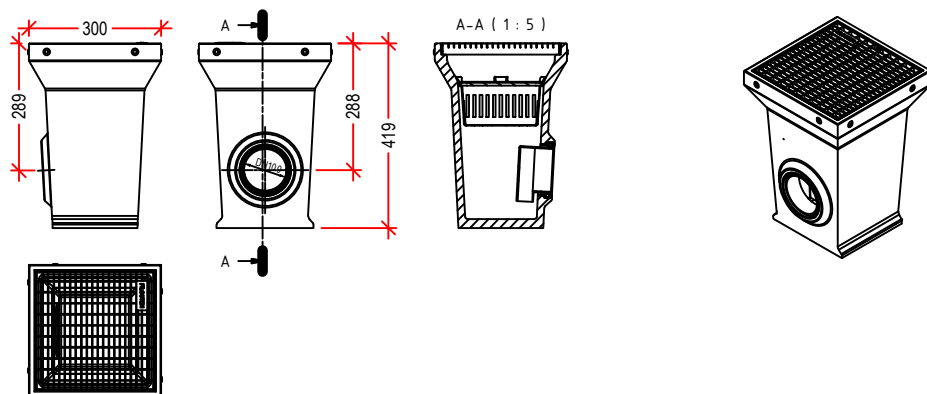

Tačkasta drenaža sa mrežastom rešetkom-mogućnost prolaska automobila, kolicom za mulj i sifonom

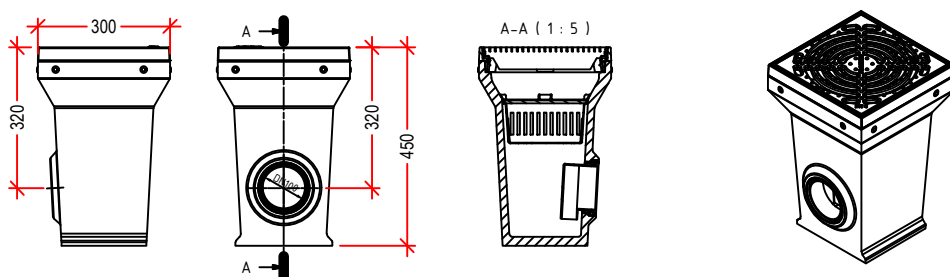

Mrežasta rešetka:  
 Art br.: 14130101; 24,8kg

Liveo gvozdена rešetka:  
 Art br.: 14130102; 26,7kg

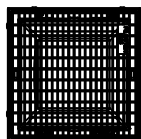

Dodaci:

Element-nastavak  
 Art br.: 14130020; 12,3kg

Element-nastavak sa izlivom DM 122  
 Art br.: 14130023; 11,4kg

Kofica za mulj od plastike NW200  
 Art br.: 19025401

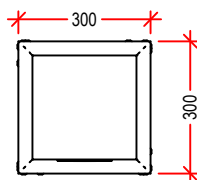
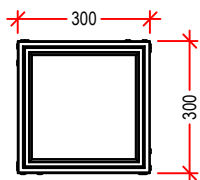
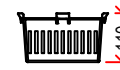
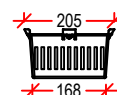
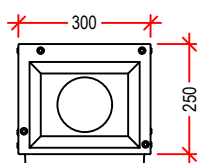
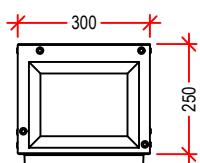

**purator**  
 serbia  
 member of the walter & neubert group

PURATOR Ekotehnika d.o.o.  
 ul. Kružni put 16a  
 Beograd, Leštane  
 office@purator.rs  
 tel.: +381 11 803 10 52  
 faks: +381 11 803 08 26  
 www.purator.rs



www.bg-company.com

Naziv crteža: **TAČKASTO ODVODNJAVANJE-Dvorišni slivnik NW200**  
 Drawing name:

Art.br: 14130001

format:  
 scale:

A4